

Varenummer: 20171V452SW
 Beskrivelse: E+G
 Bred hjørne holder GN171-V45-2-SW

Mål

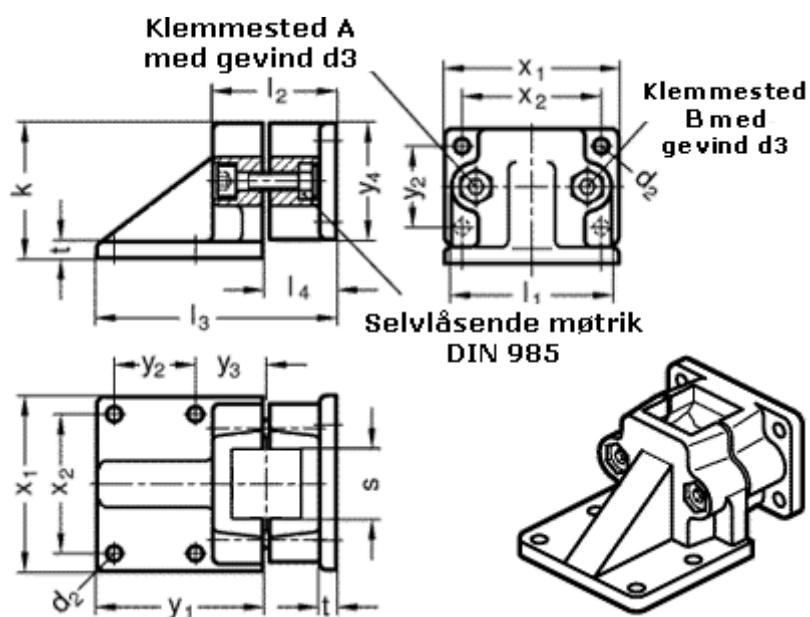

$d_2 = 11$	$t = 14$
$d_3 = M10$	$x_1 = 115$
$k = 91$	$x_2 = 90$
$l_1 = 98$	$y_1 = 108$
$l_2 = 82$	$y_2 = 50$
$l_3 = 156$	$y_3 = 45$
$l_4 = 47$	$y_4 = 76$
$S = V45$	